

CLOUD  FOUNDRY

Intro to Cloud Foundry

Tim Harris

Director of Certification, Cloud Foundry Foundation



Introductions

Cloud Foundry Foundation

- *5.0.1 (c) 6, Not for profit*
- *Supports community and code*
- *Part of Linux Foundation*

Speaker: Tim Harris

- *PhD in Computer Science*
- *Time at Oracle and VMware*
- *Training and Cert at Cloud Foundry Foundation*

Agenda

Intro to PAAS

Why Cloud Foundry?

Developing Applications on CF

Cloud Native in CF

Services and Routes

Multi-Cloud and Heterogeneous Platforms with CF

Platform as a Service

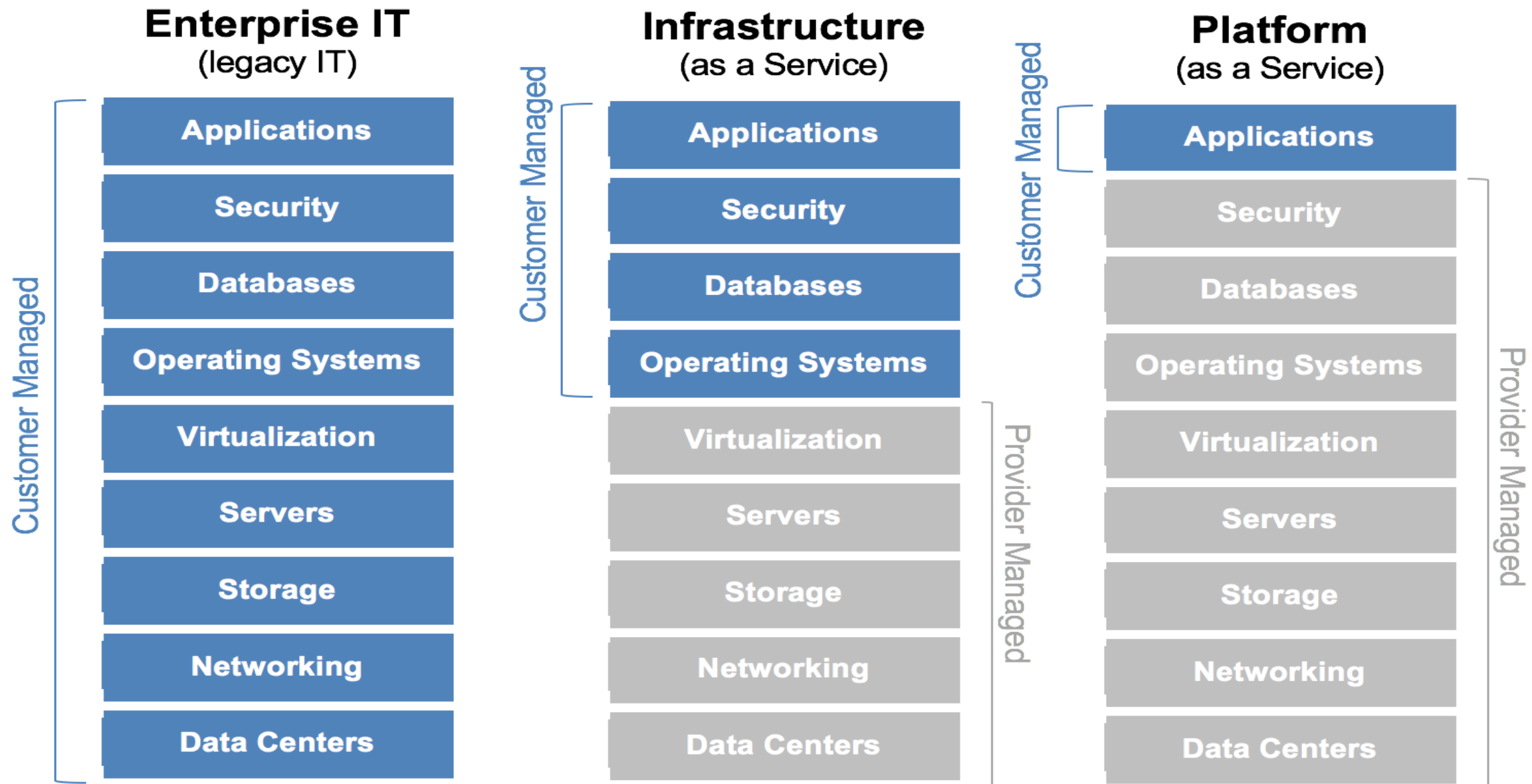

Platform as a Service

High level of abstraction

- *Broad “opinions” about how things are done best*
- *Less work to implement if you align with those assumptions*

Increase agility of developers

- *Quickly iterate on production deployment*
- *Reduce churn between silos*

Dev-Ops Virtuous Cycle

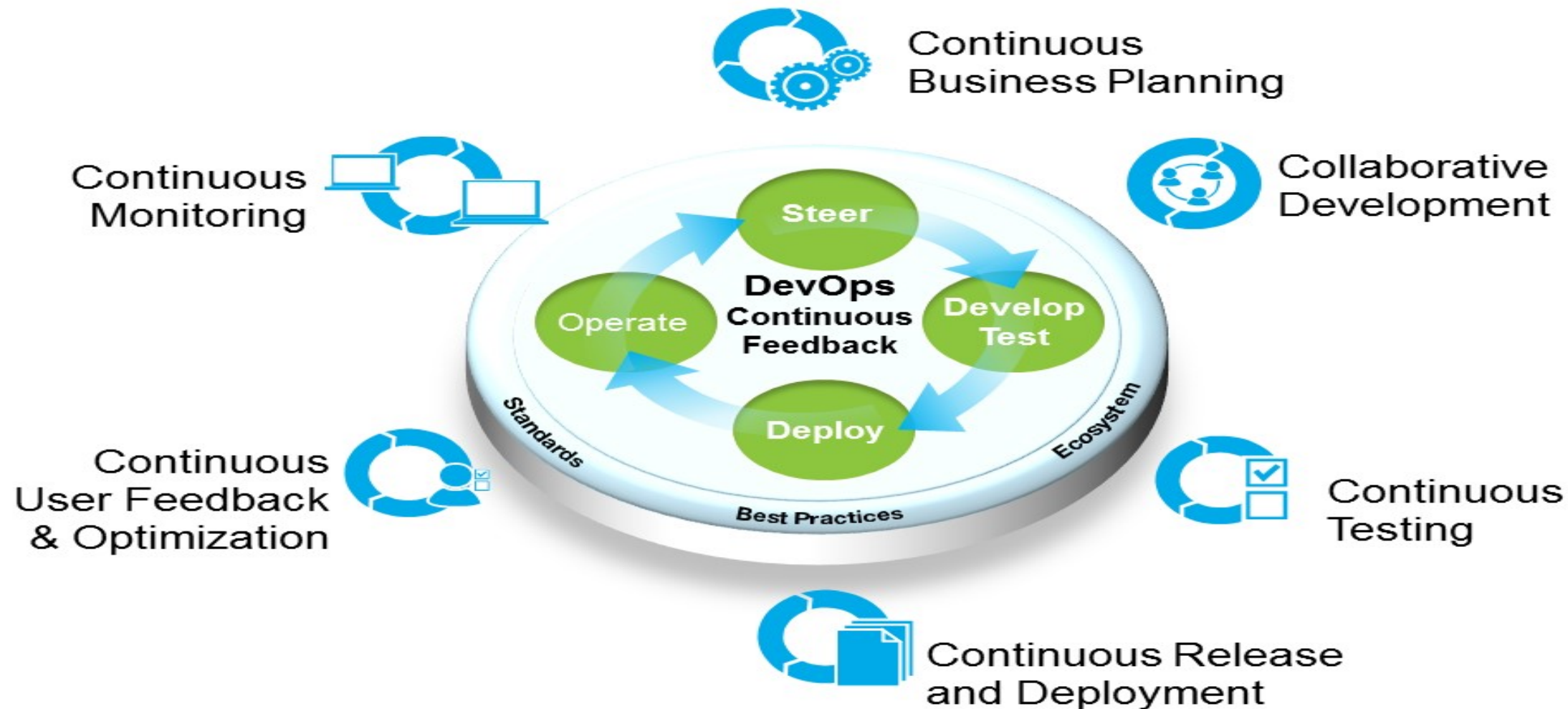

Dev-ops Context

Cloud Foundry Lives in automated world

- *But doesn't live alone*
- *E.g. CI/CD toolset has high value*

CF Developers less dependent on other teams

- *Testing, Staging, Production Deployment, Operations*

Iterative improvement vs large releases

- *Reduce cost per deployment*
- *Decrease time to market*

Container Orchestration vs PAAS

Container Orchestration (e.g. Kubernetes)

- Lower level of abstraction*
- More control and hence more complexity*
- Users manage their own containers*

PAAS

- Higher level of abstraction*
- Less control but likely more productivity*
- Platform manages containers (generally)*
- Platform manages buildpacks, dependencies, security and routing*

Kubernetes and PaaS



Matt Cholick @cholick · Aug 7

Remember reading this in 2017 & not believing: [twitter.com/kelseyhightowe....](https://twitter.com/kelseyhightower)
Since then, having spent many sprints with K8s, learned it's 100% true. Working with [@cloudfoundry](https://cloudfoundry.org) for 4 years and K8s for ~1: raw K8s has the primitives for building platforms; it's not a tool to deploy apps

Kelsey Hightower  @kelseyhightower

Kubernetes is a platform for building platforms. It's a better place to start; not the endgame.



Container Orchestration vs PaaS

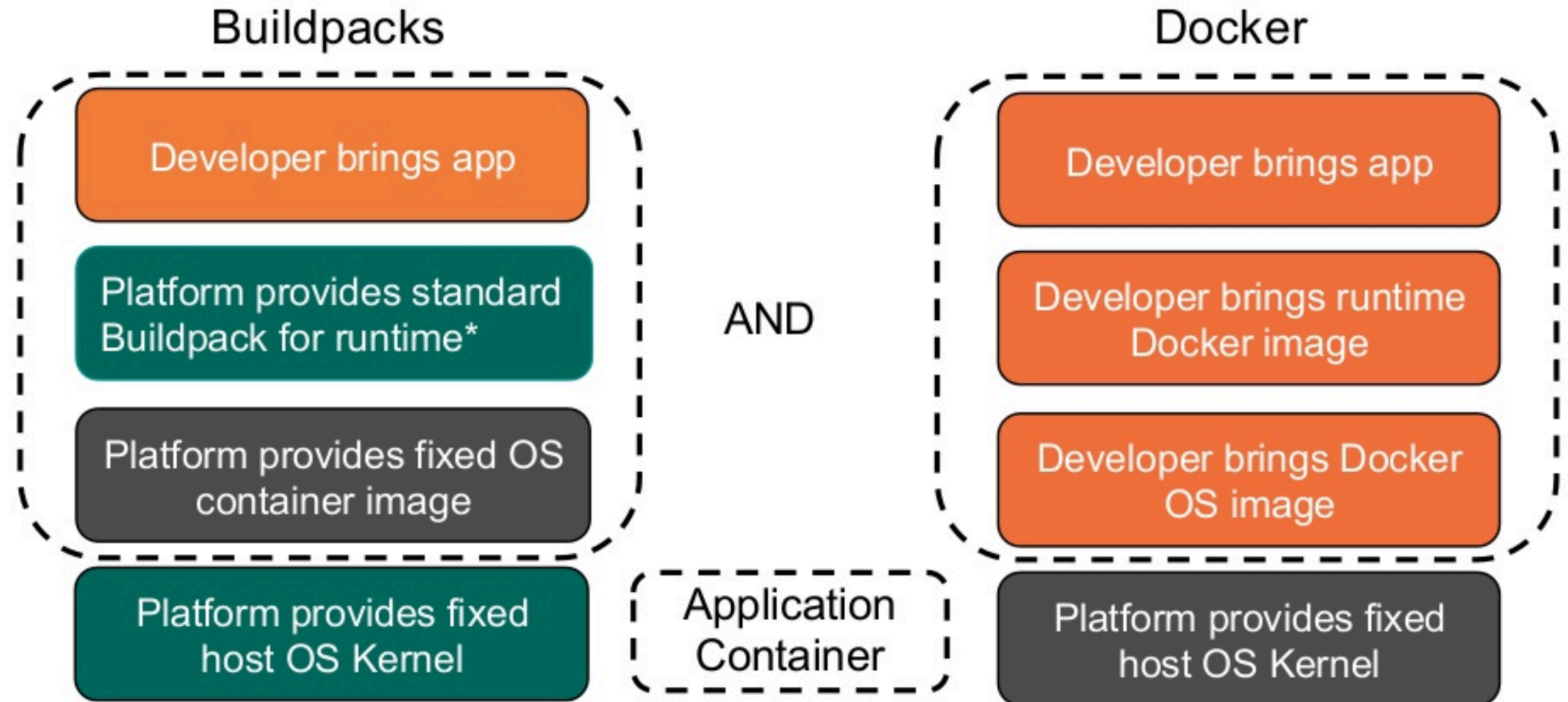

CLOUD  FOUNDRY

—

Developing Applications on Cloud Foundry



“Here is my source code
Run it on the cloud for me
I do not care how”

Cloud Foundry Haiku

Onsi Fakhouri

cf push

Buildpacks

Multi-language and Extensible

- *Bring your own buildpack or use available ones*

Automated detection

- *Identifies needed dependencies and provides them*

User provide app + buildpack = droplet

- *Executable container ready to stage and execute*

CF Buildpacks and Applications

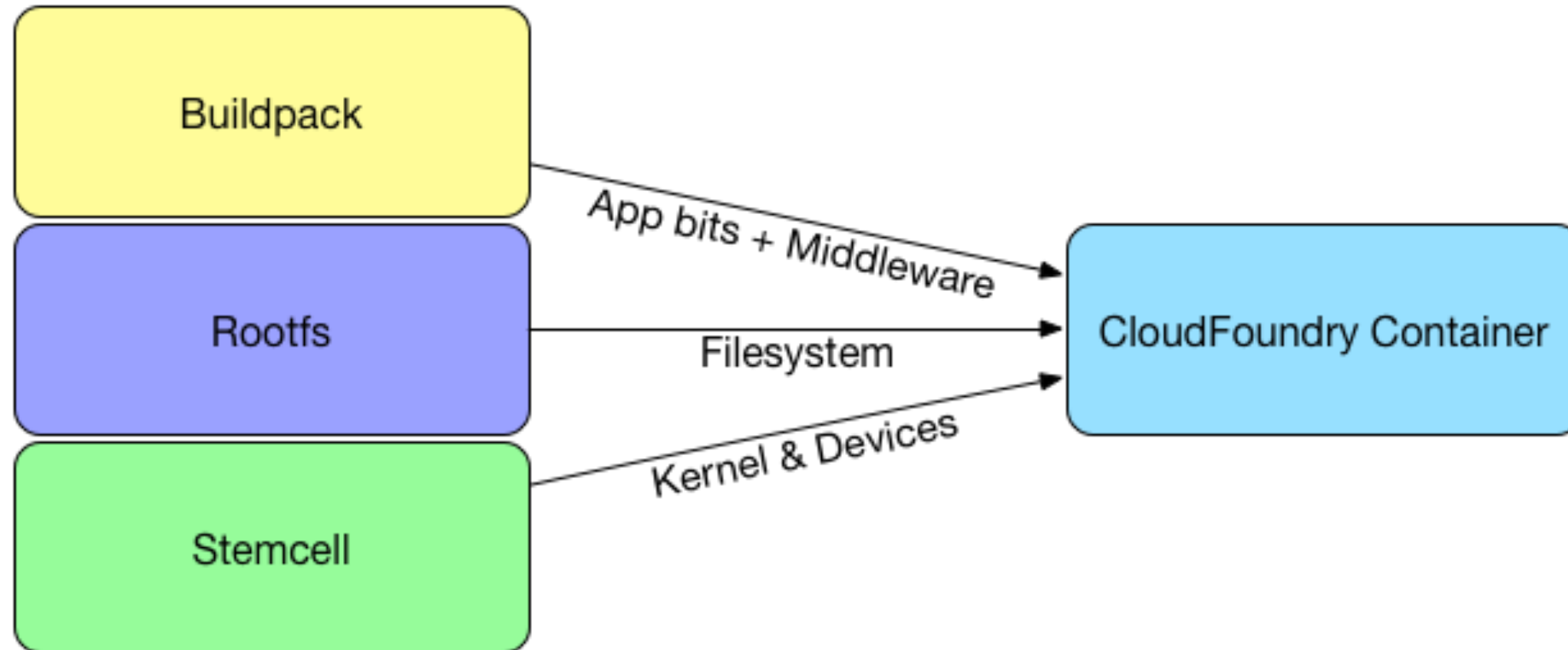

Command Line Interface (CLI)

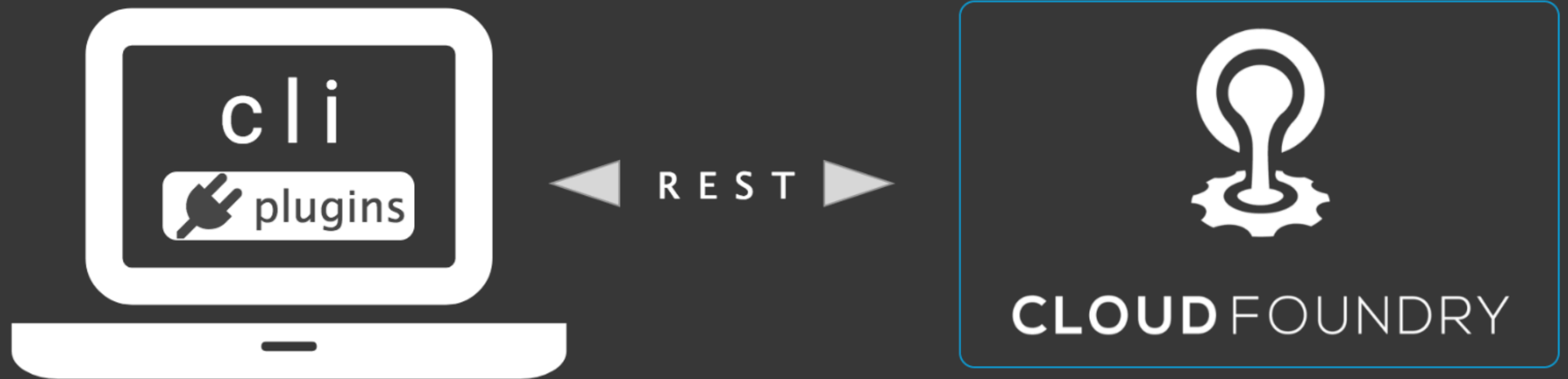

Access to Resources in CF

Organization / Space

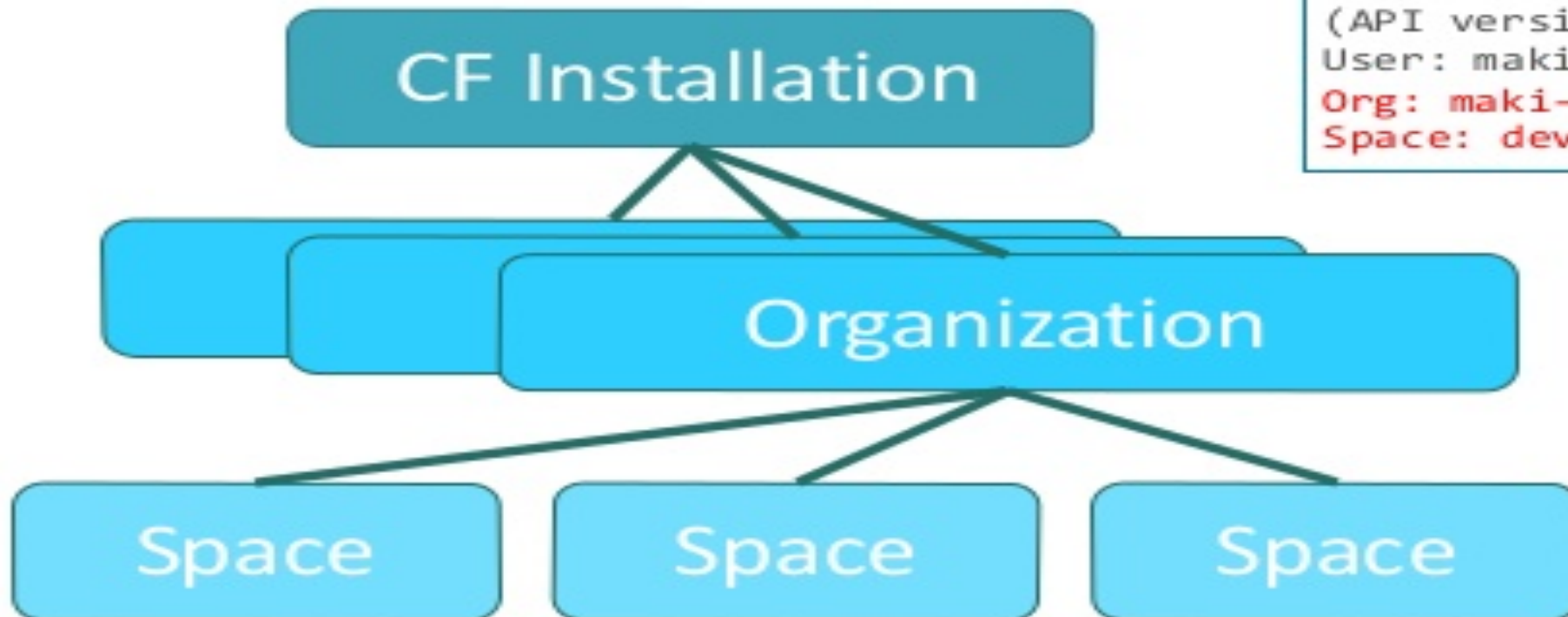

```
$ cf login -a https://api.run.pivotal.io
OK
Targeted org maki-org
Targeted space development

API endpoint: https://api.run.pivotal.io
(API version: 2.51.0)
User: maki@example.com
Org: maki-org
Space: development
```

User, Role, Quota

Development,
Staging,
Production

Multi-tenancy in CF

Multiple tenants share a given CF instance

- Full isolation of user processes and data*

Org typically shared by team of users

- Each space may belong to a single user*

Cloud Foundry has relatively large footprint

- Proportional to level of services provided*
- CF instances often have over 40 VMs in full deploy*

Diego: Container Orchestration for CF Cells

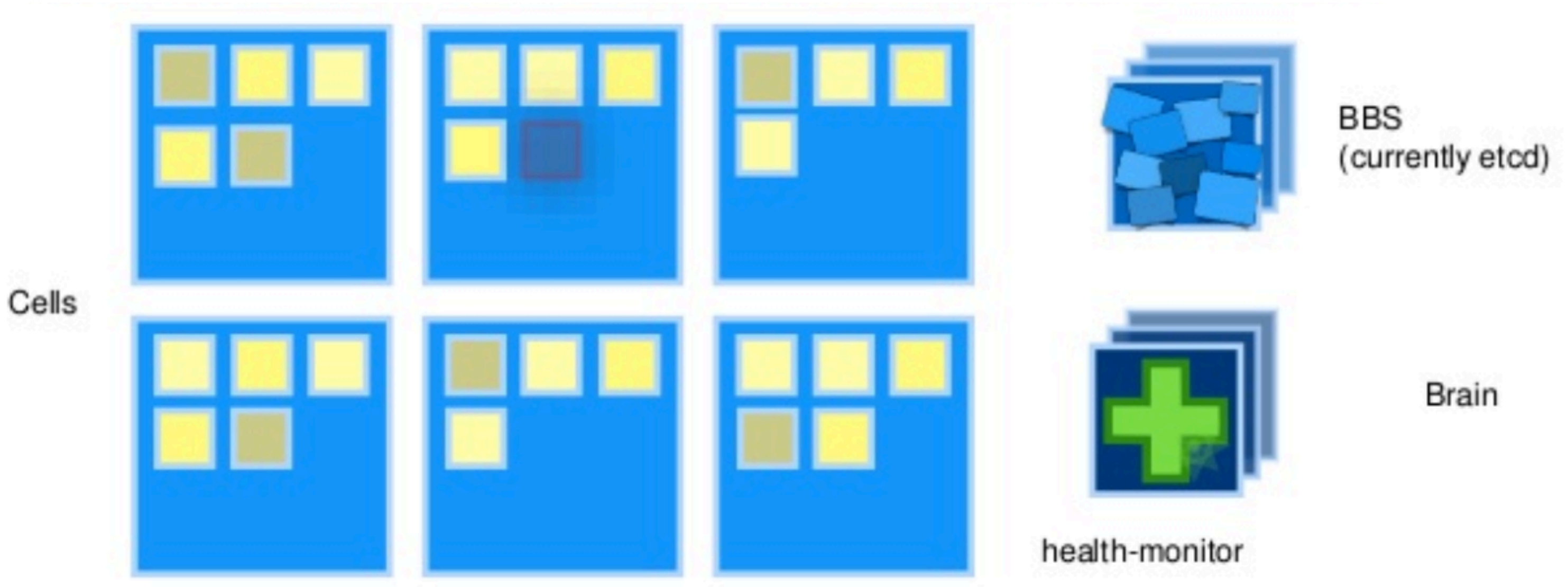

CF Routes

Allocated by default after a CF Push

- *Default domain like cfapps.io or cloudfoundry.org*

Routes can be fully specified or randomized

- *Slack.cloudfoundry.org or slack-unridiculed-checkup.cloudfoundry.org*
- *Random routes avoid route conflicts*

Loadbalancer across instances by default

Routes have lifecycle of their own

- *Separate from the apps they route to*

Ingress in CF: Routes

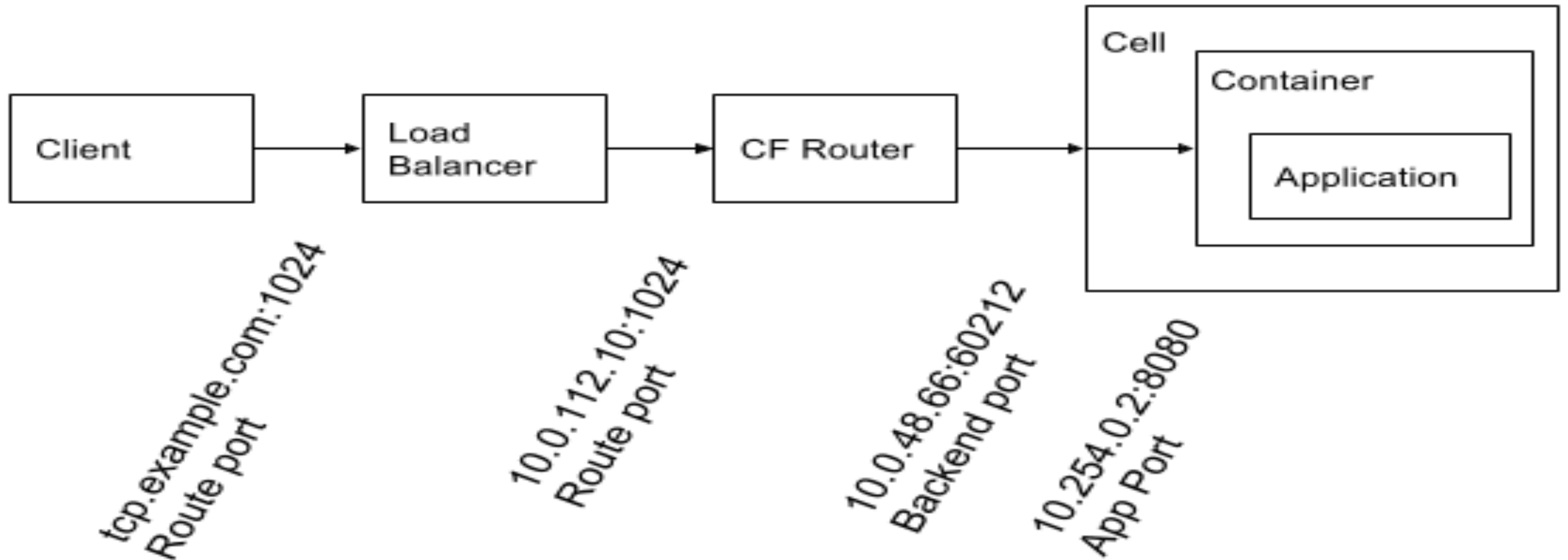

User Authentication and Authorization

UAA is built into platform and manages:

- *Authentication: Who are you?*
- *Authorization: What can you access?*

Implements Oauth 2.0 Standard

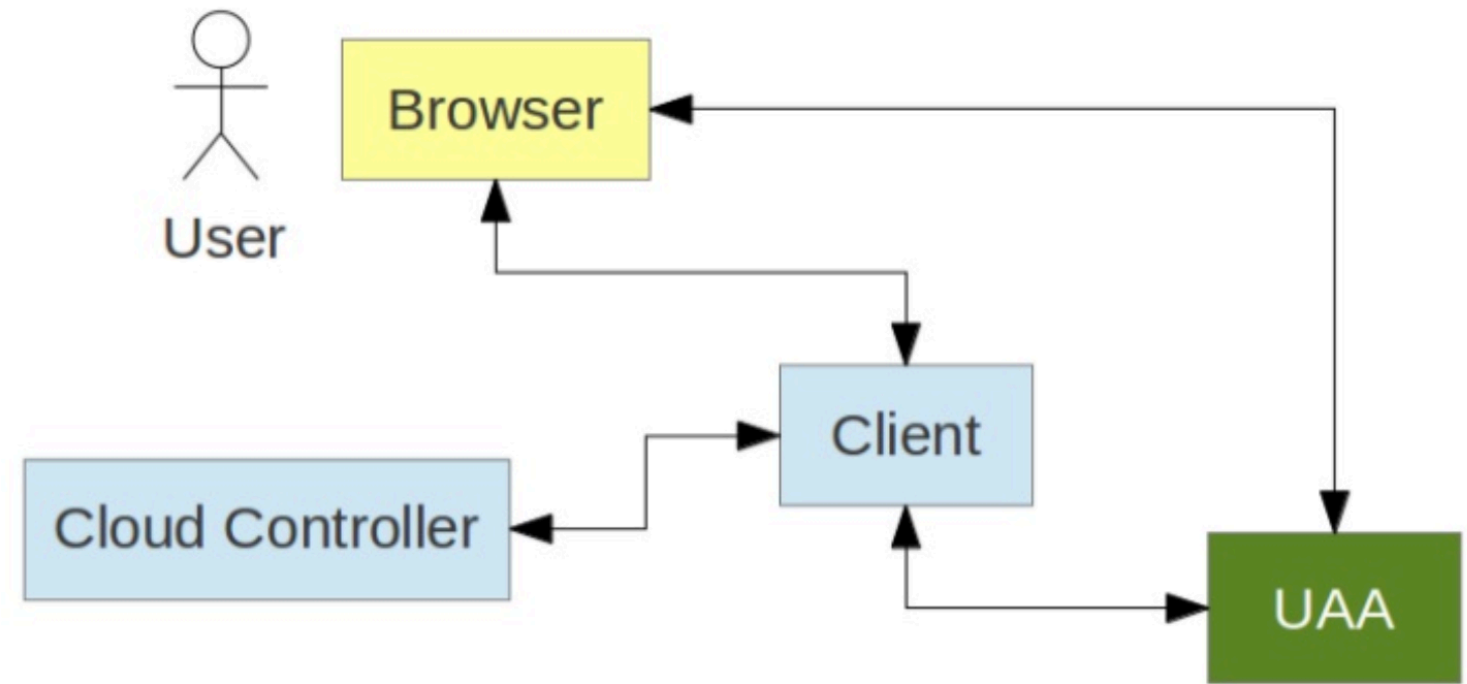

CF Components Review

CF Push Experience

- *Using buildpacks to build containers dynamically*

Diego application runtime

- *Pushes composed droplets to cells for execution*
- *Manages scaling and availability at runtime*

Routes provide ingress by default

Authentication and Authorization via UAA component

CLOUD  FOUNDRY



Cloud Native in CF

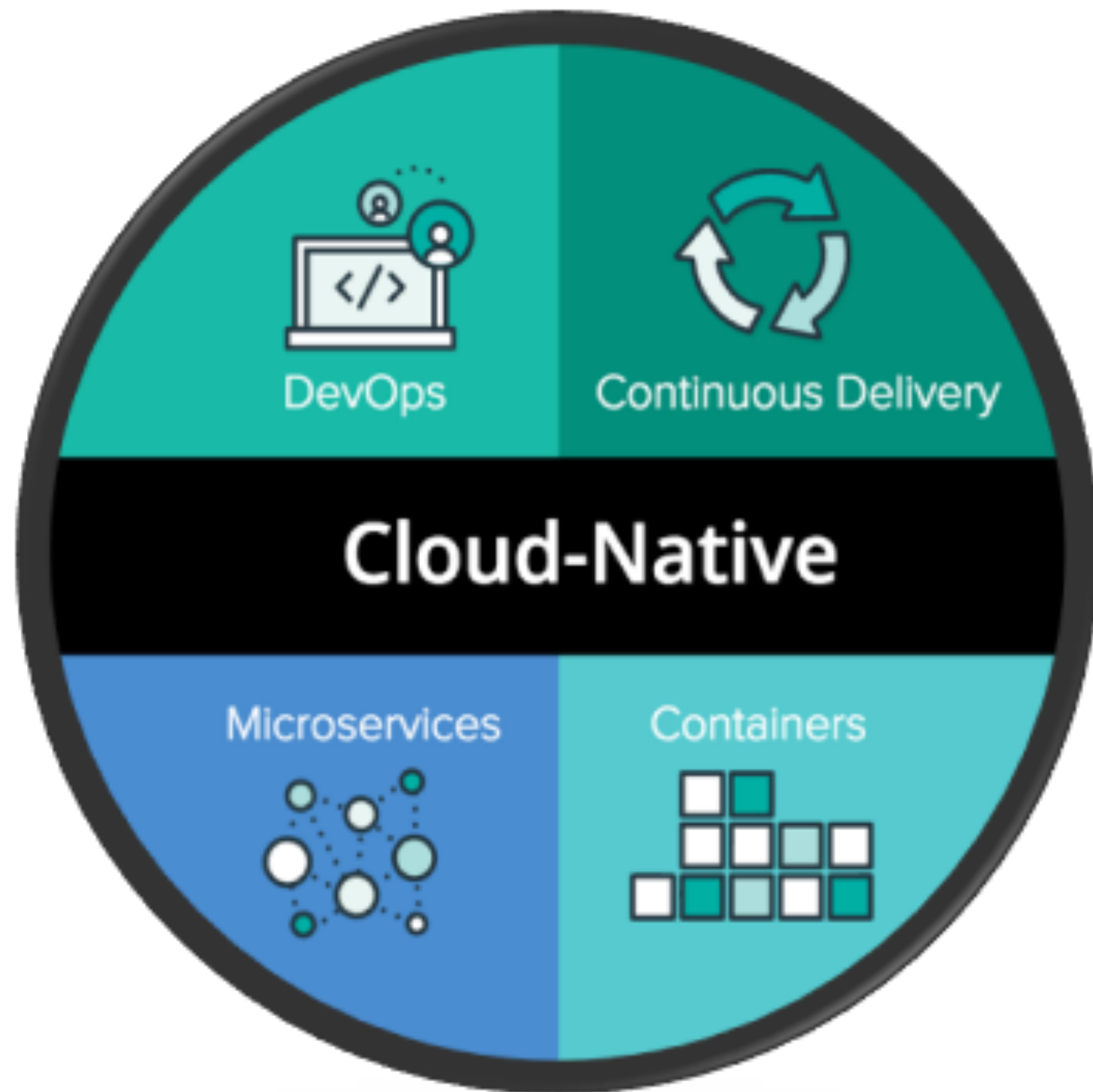

Cloud Native Apps in CF

Monolith vs Micro-services

- *Reusable components*
- *Separation of Concerns*

Stateless and Scalable

- *Assume apps are ephemeral*
- *State is kept external to App*

Roughly aligned with 12-factor methodology

- *12factor.net*

CLOUD  FOUNDRY



Backing Services in CF

CF Marketplace

```
[tharris:~/concourse/ci/class-site-pipeline] $  
[tharris:~/concourse/ci/class-site-pipeline] $ cf marketplace  
Getting services from marketplace in org cloudfoundry-summit-training / space training as tharris@cloudfoundry.org...  
OK
```

service	plans	description
Greenplum	Free	Greenplum for Pivotal Cloud Foundry
MongoDB-cc ion	standard	A simple MongoDB service broker implementat
app-autoscaler ad	standard	Scales bound applications in response to lo
blazemeter	free-tier, basic1kmr*, pro5kmr*	Performance Testing Platform
cedexisopenmix alancer	opx_global*, openmix-gslb-with-fusion-feeds*	Openmix Global Cloud and Data Center Load B
cleardb	spark, boost*, amp*, shock*	Highly available MySQL for your Apps.
cloudamqp	lemur, tiger*, bunny*, rabbit*, panda*	Managed HA RabbitMQ servers in the cloud
cloudforge	free, standard*, pro*	Development Tools In The Cloud
elephantsql	turtle, panda*, hippo*, elephant*	PostgreSQL as a Service
gluon n	free, indie*, business*, enterprise*	Mobile Synchronization and Cloud Integratio
ironworker	production*, starter*, developer*	Job Scheduling and Processing
loadimpact	lifree, li100*, li500*, li1000*	Performance testing for DevOps
memcachedcloud	100mb*, 250mb*, 500mb*, 1gb*, 2-5gb*, 5gb*, 30mb	Enterprise-Class Memcached for Developers
memcachier	dev, 100*, 250*, 500*, 1000*, 2000*, 5000*, 7500*, 10000*, 20000*, 50000*, 100000*	The easiest, most advanced memcache.
metrics-forwarder	unlimited, 4x4000, 60x60000	Custom metrics service
mlab	sandbox	Fully managed MongoDB-as-a-Service
newrelic	pro*	Manage and monitor your apps
p-circuit-breaker-dashboard Applications	standard*, trial	Circuit Breaker Dashboard for Spring Cloud
p-config-server	standard*, trial	Config Server for Spring Cloud Applications
p-service-registry ons	standard*, trial	Service Registry for Spring Cloud Applicati

Cloud Foundry Services

External to consuming apps

- *Leaving apps stateless and scalable*

Self-service provisioning

- *No demands on IT*

CF Broker and Marketplace

- *Broker is app that implements Open Source Broker API*
- *Marketplace entry has Service name, plan and cost*

Service instance life-cycle

- *Create service instance (service/plan)*
- *Bind service to app*
- *Unbind and delete service*

CF Service Broker

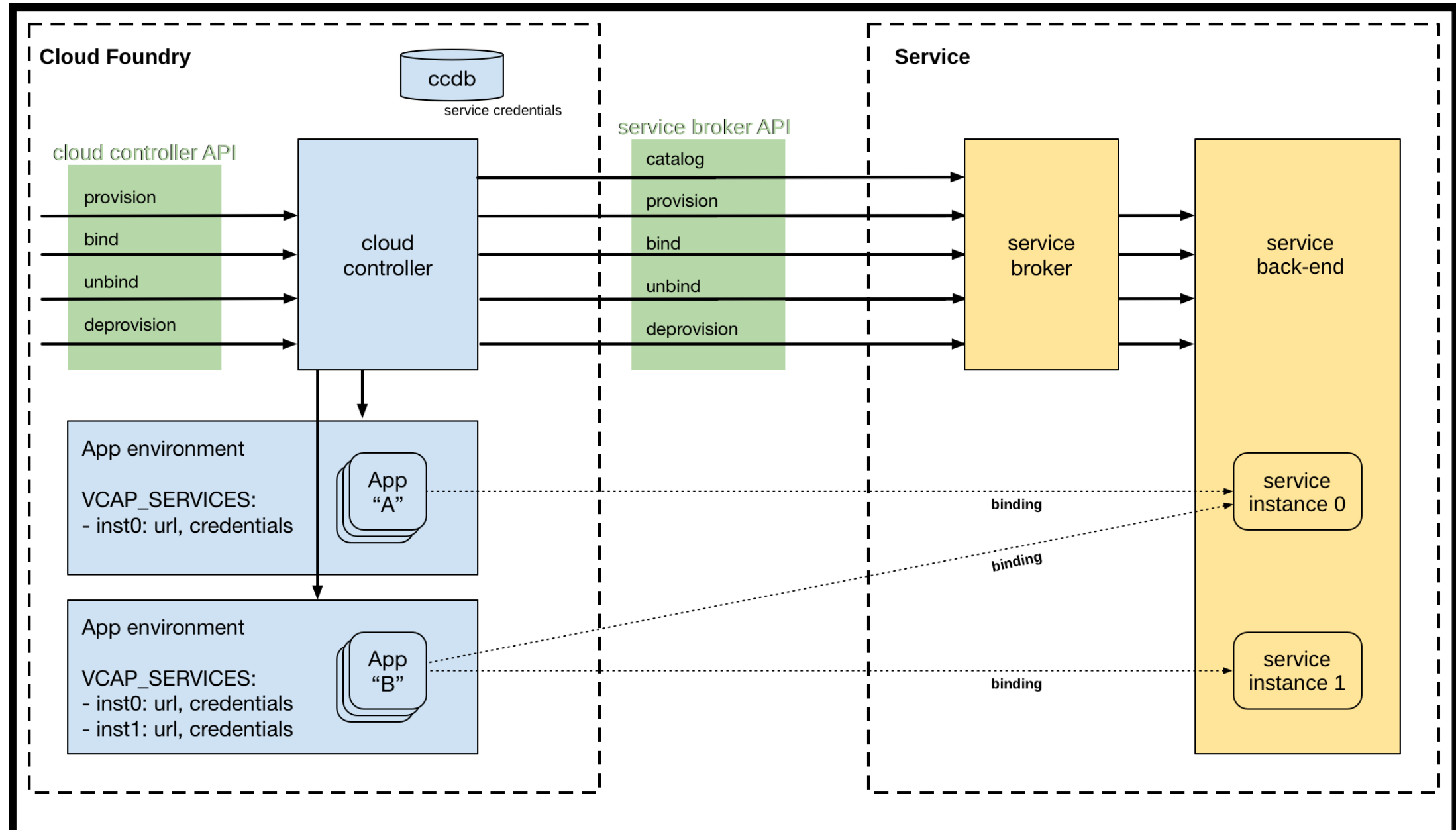

CLOUD  FOUNDRY



Multi-platform and Multi-cloud

BOSH's role in Cloud Foundry



Most common deployment method

- *Bosh release specifies needed VMs and processes*
- *Kubernetes deploy also possible*

Cloud Provider Interface (CPI)

- *Shim between Bosh and IAAS provider*
- *Maximizes portability across cloud*

Supports high availability

- *Monitors and restarts VMs and processes*

Bosh and Cloud Foundry

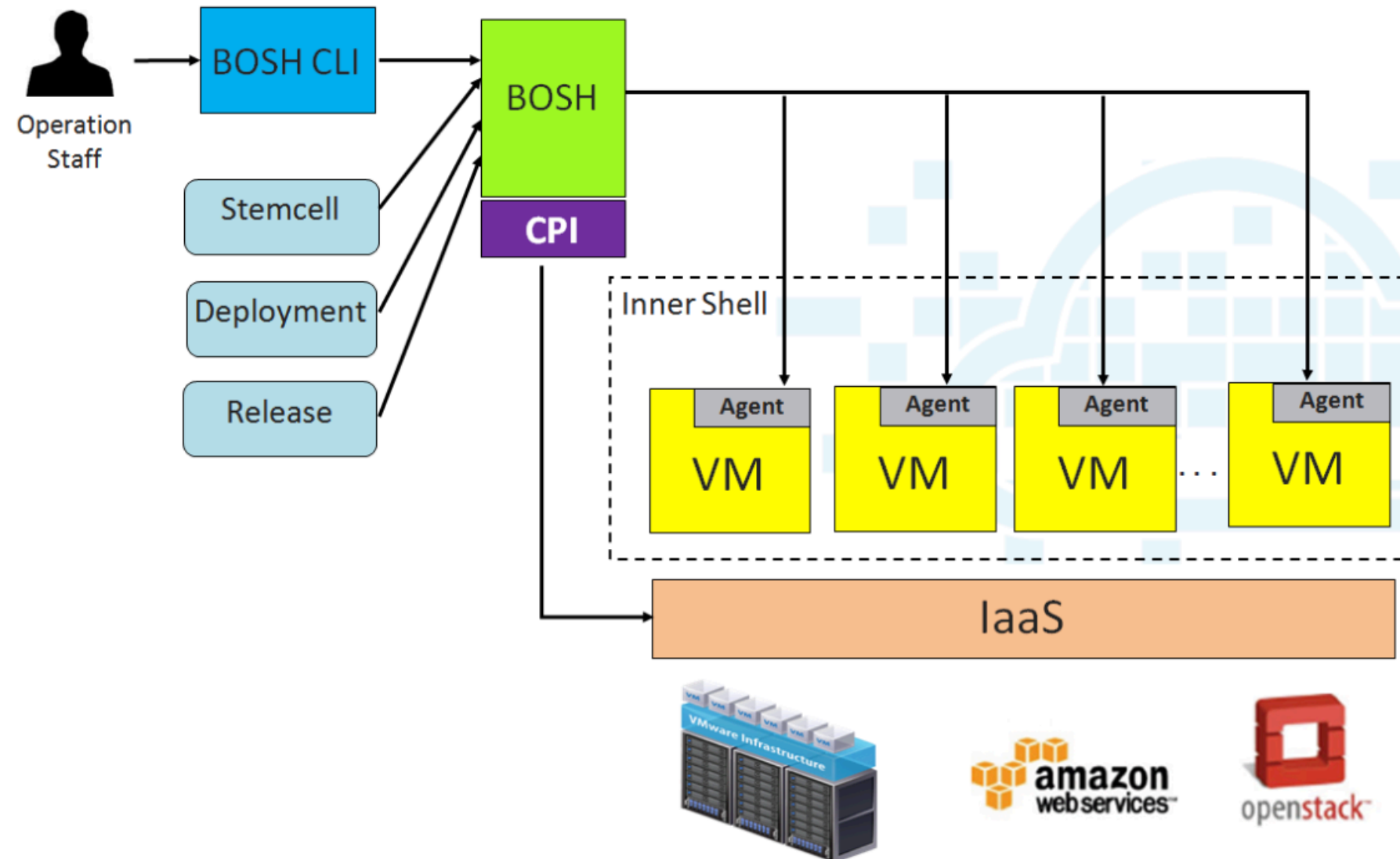

Cloud Foundry and Multi-cloud

Cloud Foundry has no knowledge or interest in underlying IAAS

- Bosh deploys VMs via CPI*

Portable platform runs on many platforms

- AWS, GCP, Azure, Openstack, private cloud*

Diversify investment across vendors

- Mix private/public cloud solutions*
- Run on all IAAS with no change*

PLATFORM CERTIFICATION



Atos

Pivotal

The Huawei logo, featuring a red flower-like icon above the text "HUAWEI" in white, set against a background of three people sitting on the floor and using their phones.

HUAWEI

IBM

The SAP logo, featuring the text "SAP" in white on a blue background, set against a background of a city skyline at night.

SAP

The Swisscom logo, featuring a red and white flag icon above the text "swisscom" in white, set against a blue background.

swisscom

Cloud Foundry Container Runtime

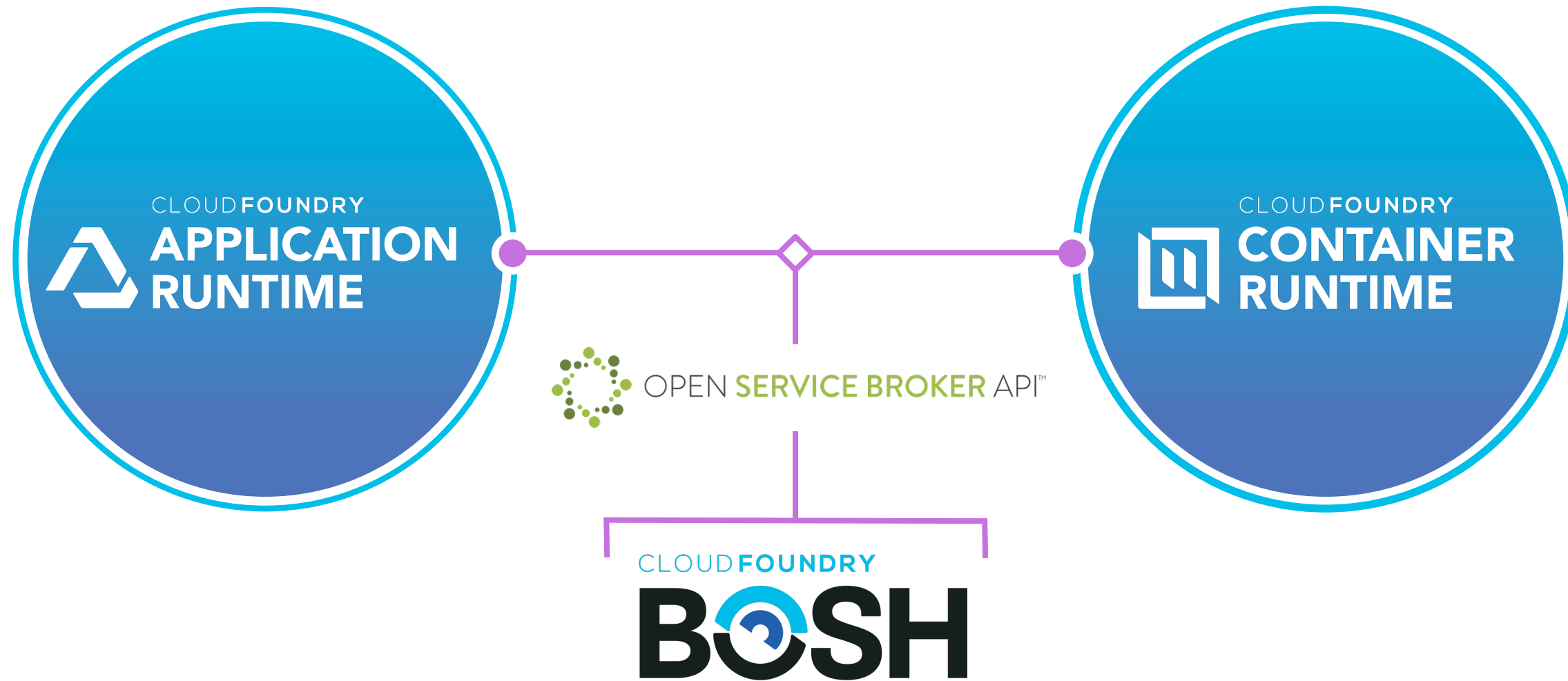

Container Runtime in CF

Kubernetes based container orchestration

- *Available on integrated platform*

Allows different deployment models for different applications

- *All sharing same infrastructure*

Deployed via BOSH as with CF

- *Provides day-2 operational support that we expect*

THE ECOSYSTEM

Expanding capabilities



CPIs for IaaS

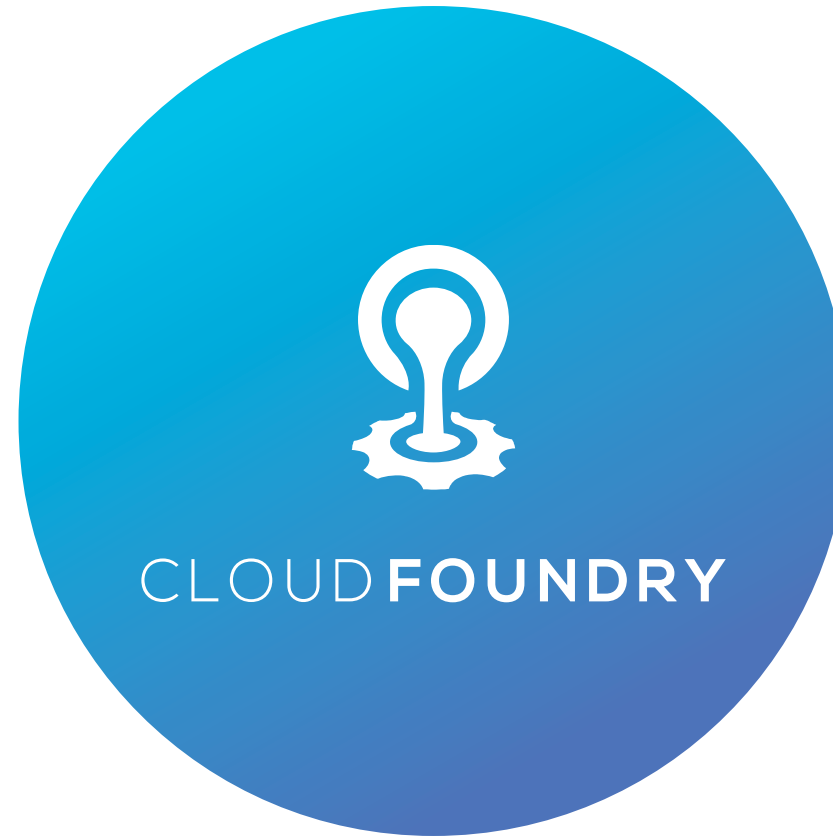

Service Brokers



Integrators

CLOUD FOUNDRY IS USED BY

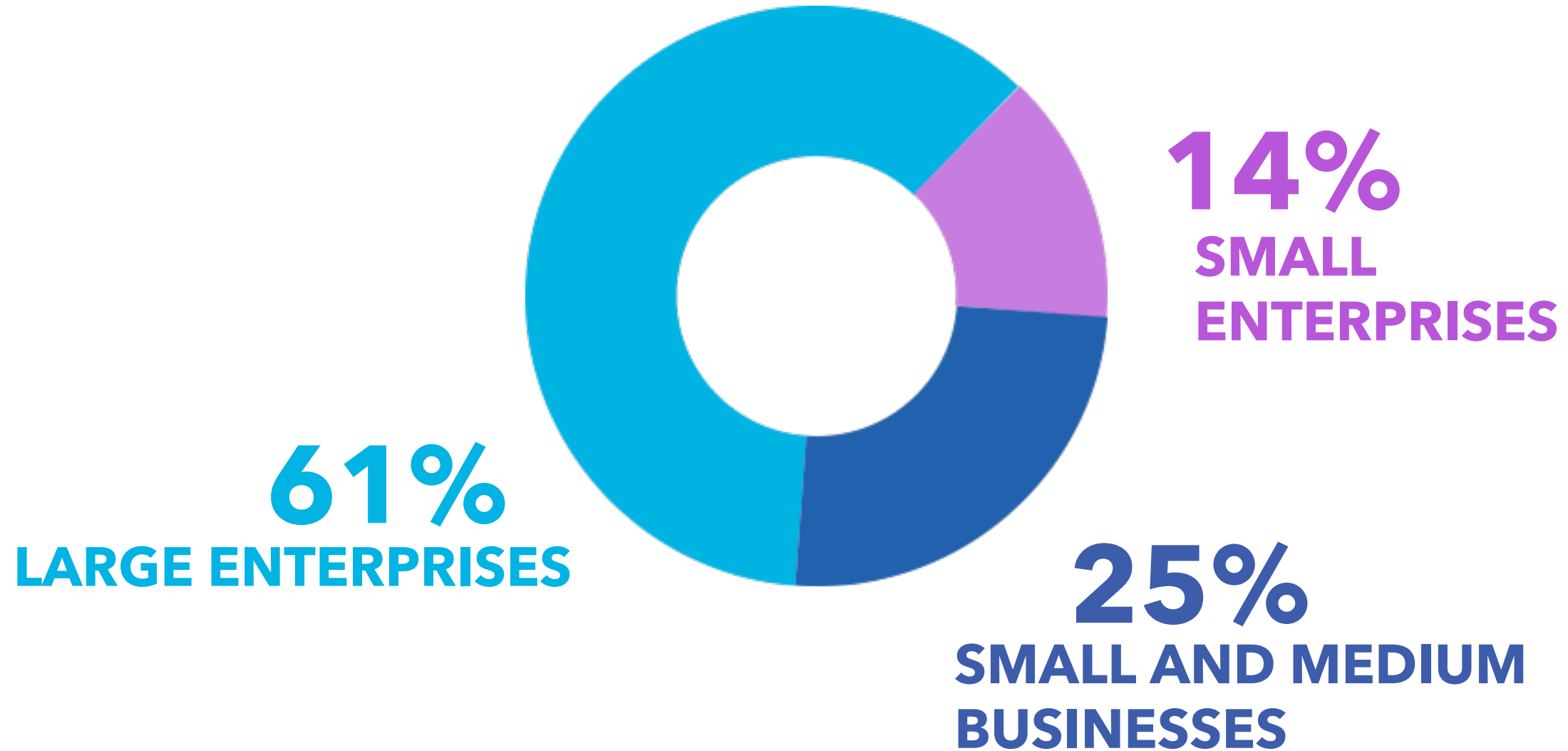

Kubernetes Integration Experiments

CF Container Runtime

- *Kube as a service*

Eirini – Kubernetes as a Application Runtime

- *Replacing Diego runtime with Kubernetes*

Bosh CPI for Kubernetes

- *Deploy containerized CF via Kubernetes*

Istio/Envoy for Cloud Foundry

- *Service Mesh and Authentication for External Services*
- *Common tools in Kubernetes Ecosystem*

INTEROPERABILITY

VELOCITY

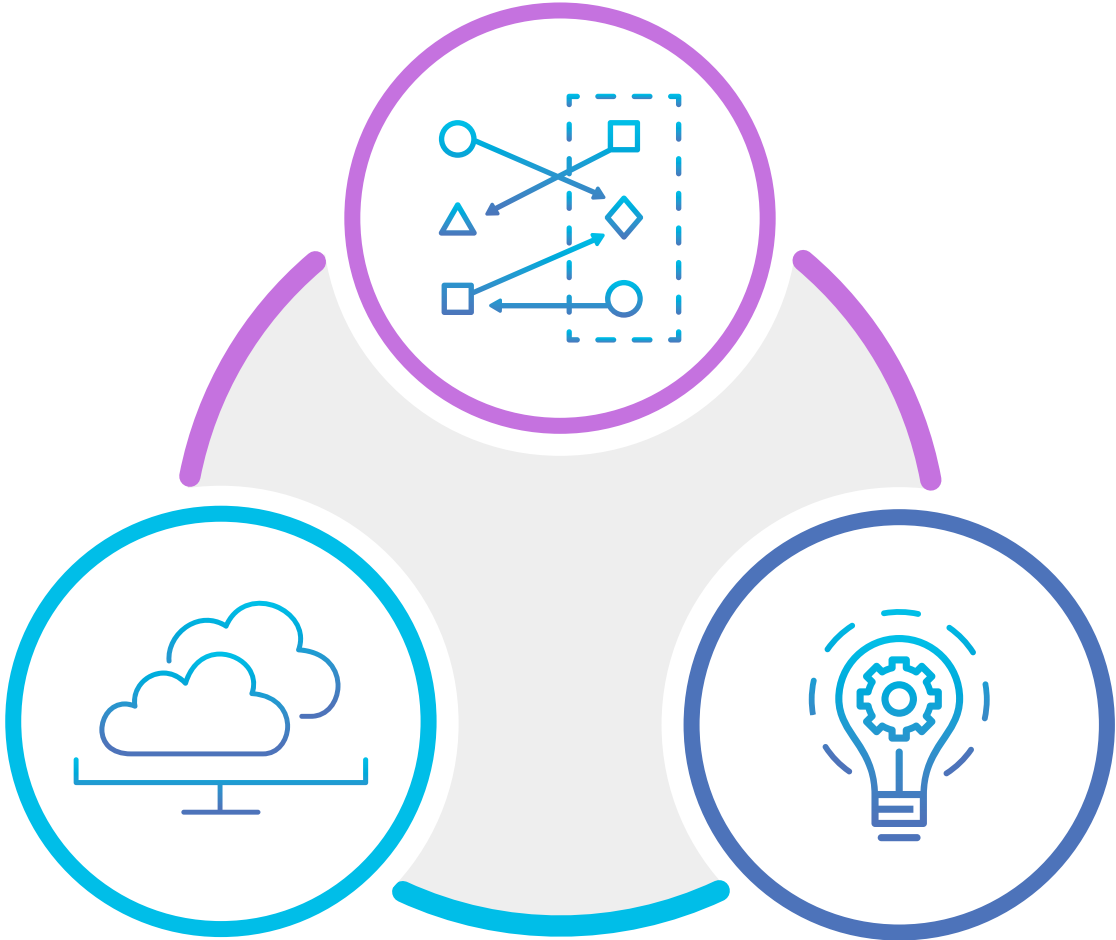

INNOVATION

Summary

Increase developer velocity

- *Devops automation*
- *Cloud Native design principles*
- *Scalable, Securable, Deployable*

Leverages best of OSS communities

- *Integration to container orchestration*
- *Separation of concerns in services*
- *Building integrations to Istio, Envoy, open service broker API, etc*



**THANK
YOU**

CLOUD  FOUNDRY